

AETERNA

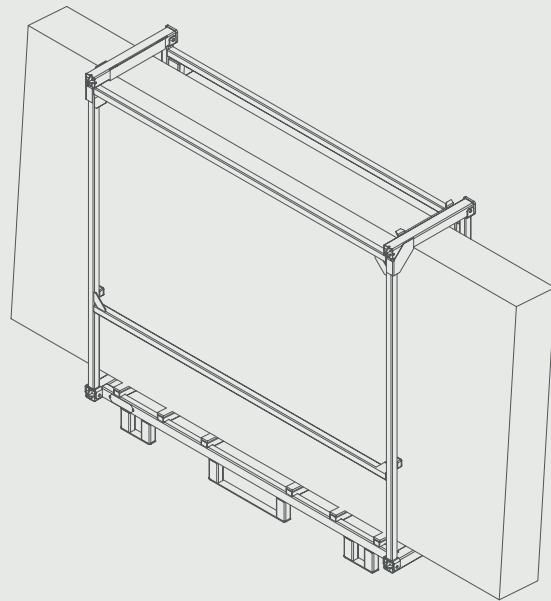

INDEX

INTRODUCTION	3
PRODUCT, SLAB SPECIFICATION	4
PACKAGE HANDLING, TRANSPORT AND STORAGE	5
PACKAGING	5
PACKAGE HANDLING AND STORAGE	6
TRANSPORT LOADING	8
CONTAINERS	8
TRUCKS	9
PRODUCT HANDLING AND STORAGE	10
THE WORLD OF ANATOLIA	16
RESOURCES	17

INTRODUCTION

Anatolia® holds a prominent position in the global surfaces industry. Continuous innovation, technological research, an international outlook, and social and environmental responsibility are the core values that Anatolia® has consistently upheld in its ongoing pursuit of excellence. The construction of the new Anatolia® factory, located in the majestic Gulf of Izmir, is where Aeterna™ Sintered Slabs are produced.

The company's investment in the production of Aeterna™ Sintered Slab is groundbreaking, demonstrating its unwavering commitment to empowering valued customers in an ever-changing and highly competitive industry. Anatolia® is poised to take the lead in meeting the surging demand for slabs with its exceptional offerings of Aeterna™ Sintered Slabs.

Aeterna™ Sintered Slabs are crafted with a sustainable approach and optimized logistics efficiencies, offer a hygienic and waterproof solution. They stand resilient against UV rays, fire, and high temperatures, as well as scratches, impacts, ice, and frost. Additionally, they repel chemicals and stains, all while being securely packaged for superior protection.

PRODUCT, SLAB SPECIFICATION

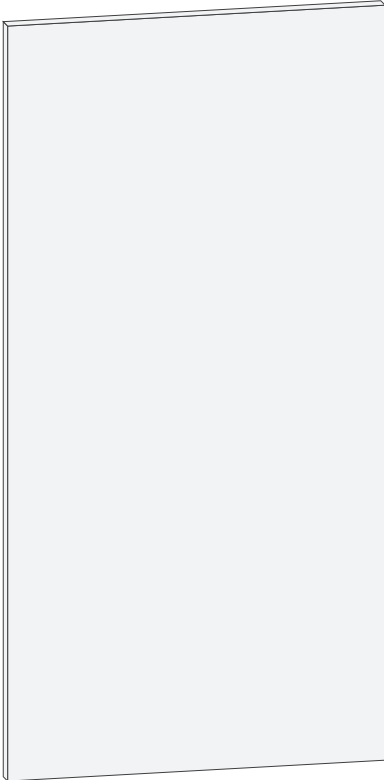

SIZE
160 x 320 cm

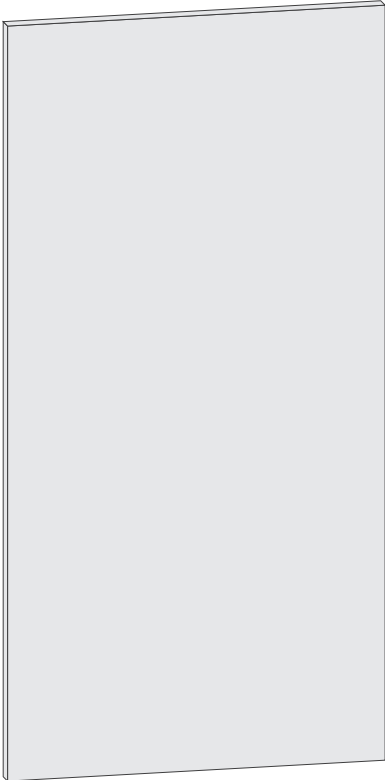

SIZE
162 x 322 cm

SLAB SPECIFICATIONS

THICKNESS	6 MM	12 MM
SIZE	160 X 320 CM	162 X 322 CM
M ²	5.12	
SQFT	55.11	
KG	75	150
LB	165.3	330.7
KG/M ²	14.65	29.3
LB/SQFT	2.93	5.86
EDGE	RECTIFIED	NON-RECTIFIED

The values provided are indicative; please use as a general guide.

PACKAGE HANDLING, TRANSPORT AND STORAGE

The information presented in this manual should be treated as suggested guidelines only. Each individual distributor and/or fabricator of Aeterna™ Sintered Slab is responsible for determining the appropriate handling, fabrication and installation methods based on their individual experience, knowledge and equipment as well as the requirements of the specific project. It is recommended that all fabricators conduct preliminary tests before final cutting and fabrication to confirm the suitability of equipment and fabrication methods.

It is recommended to work in compliance with all local laws and regulations regarding the safe handling and fabrication of Aeterna™ Sintered Slabs.

All illustrations provide product handling and processing guidance, these references are purely indicative. All rights are reserved.

PACKAGING

Anatolia® developed packaging solutions for Aeterna™ Sintered Slabs through careful research and collaboration with leading engineers, delivering a range of innovative benefits across the value chain. These solutions enhance operational efficiency in handling and distribution, improve workplace safety, and optimize storage to reduce space requirements. What sets these packaging solutions apart from others on the market is their reusability, creating a sustainable cycle that significantly reduces waste. This commitment to eco-consciousness and cost-effectiveness is further reinforced by the packaging return program.

BUNDLE-FRAMES



For orders shipping upright, slabs are placed in a Bundle-Frame. Placing slabs of more than one size on a single Bundle-Frame is not recommended. To minimize damage during transport, it is recommended that Bundle-Frames be shipped filled to capacity. Bundle-Frames are preferable to other forms of packaging if the material is to be stowed in and transported via a container for optimal stability.

SINGLE BUNDLE-FRAME SPECIFICATION

SLAB SIZE	160 X 320 CM, 6 MM	162 X 322 CM, 12 MM
BUNDLE-FRAME DIMENSIONS CM	330 X 198 X 55	
BUNDLE-FRAME DIMENSIONS INCHES	130 X 78 X 22	
SLABS PER FULL BUNDLE-FRAME	40	20
M ² PER FULL BUNDLE-FRAME	204.8	102.4
SQFT PER FULL BUNDLE-FRAME	2256	1128
WEIGHT OF FULL BUNDLE-FRAME KG	3165	
WEIGHT OF FULL BUNDLE-FRAME LBS	6980	

The values provided are indicative; please use as a general guide.

PACKAGE HANDLING AND STORAGE

HANDLING

Handling Bundle-Frames must be done with extra caution to prevent injury and damages. Before loading or unloading, ensure docks are level and all materials to be unloaded are stable and properly secured. Avoid dragging Bundle-Frames whenever possible. For optimal stability, minimize handling from the short side of the Bundle-Frames. The forklifts and cranes used must have a payload rating sufficient for loading and handling the weights detailed in the tables above. Always move only along level pathways and at a slow, steady speed. For additional guidance on material handling, contact your Anatolia representative.

HANDLING BY THE SHORT SIDE

Handling Bundle-Frames one at a time from the short side is the recommended handling option for unloading containers by forklift, not for loading or warehouse material movements. A chain and pulling equipment attachment to the forklift are recommended for pulling each Bundle-Frame out of the container once Bundle-Frame sockets are detached.

HANDLING FROM THE TOP – USING THE BUNDLE HANGER ATTACHMENT

Bundle-Frames are recommended to be handled one at a time when moving by forklift. It is recommended to move the Bundle-Frames upright along the long side with the Anatolia® designed Bundle Hanger from the TOP of the Bundle-Frame. Ensure the load backrest and the edge of the Bundle Hanger are within 35-45 cm, lift between 5-10 cm/2-4 inches off the ground. Always drive backwards with the load for better visibility.

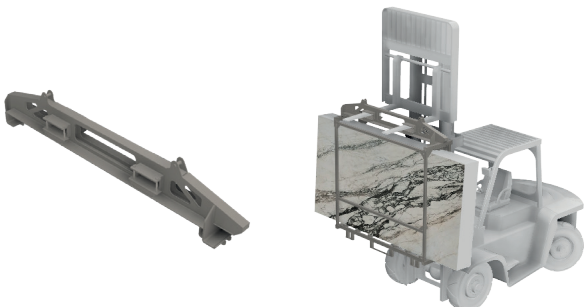

Bundle-Frames can also be moved by overhead cranes, utilizing the attachment points provided on the Bundle Hanger. When lifting, only one Bundle-Frame should be lifted at a time using the crane and Bundle Hanger.



As one option for storage, Bundle-Frames of the same type and recommended full capacity can be stacked in a pyramid shape, if preferred. Place 3 Bundle-Frames on the bottom, and 2 Bundle-Frames on top as shown below. Ensure the female and male sockets on the Bundle-Frames are secure and well-connected. Move one at a time, ensuring a minimum 5-ton forklift with a minimum 160 cm forks are used. Bundle Hanger must be placed 120 cm from the load backrest.

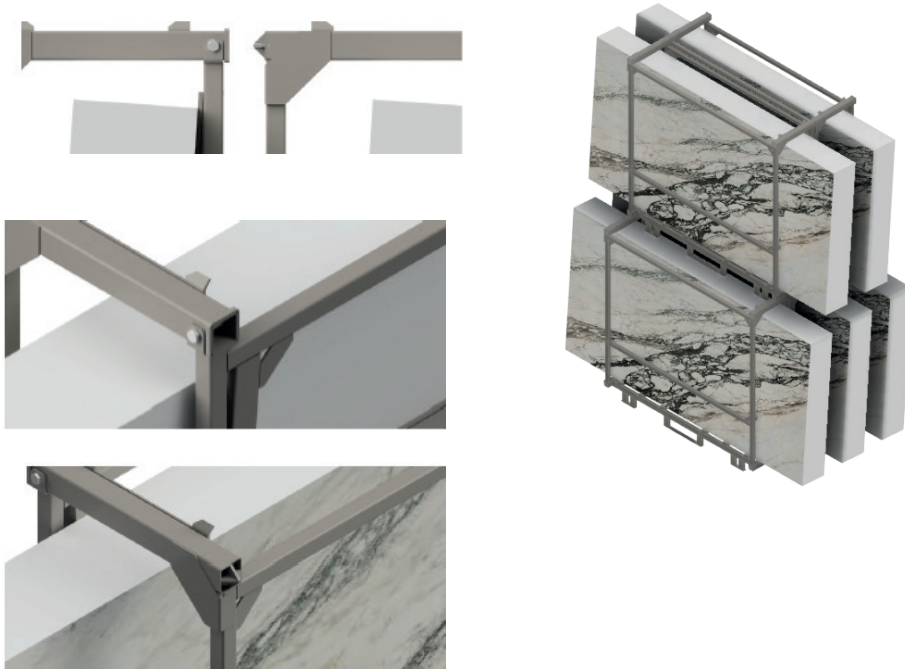

HANDLING BY THE LONG SIDE

Bundle-Frames are recommended to be handled one at a time when moving short distances by forklift. It is recommended to move the Bundle-Frames upright along the long side. Lift only 5 cm/2 inches off the ground. Once lifted, tilt backwards towards the forklift for optimal stability. Always drive backwards with the load for better visibility.

HANDLING ACCESSORY INFORMATION

MATERIAL

7414-0000-#

MATERIAL LONG TEXT

SLAB BUNDLE HANGER 5-2-2

TRANSPORT LOADING

Recommended stacking patterns are provided in accordance with the loading instructions below.

CONTAINERS

20' CONTAINER

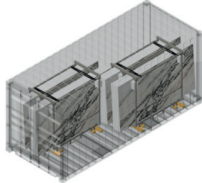
RECOMMENDED STACKING PATTERN		
THICKNESS	6 MM	12 MM
# OF BUNDLE-FRAMES	4	
# OF SLABS	160	80
M ²	819.2	409.6
KG	12428	
SQFT	9024	4512
LB	27400	

The values provided are indicative; please use as a general guide.

The quantity transported may vary depending on the weight limits of the country/region.

40' CONTAINER

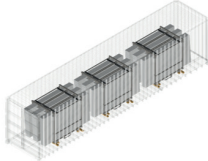
RECOMMENDED STACKING PATTERN FOR MAXIMUM SHIPPING DENSITY (CAN BE MODIFIED BASED ON LOCAL SHIPPING AND LOADING RESTRICTIONS)		
THICKNESS	6 MM	12 MM
# OF BUNDLE-FRAMES	9	
# OF SLABS	360	180
M ²	1843.2	921.6
KG	27963	
SQFT	20304	10152
LB	61650	

The values provided are indicative; please use as a general guide.

The quantity transported may vary depending on the weight limits of the country/region.

TRUCKS

Suggested loading patterns for road transport are noted below. Bundle-Frames should be loaded in the direction recommended, using the recommended material handling equipment. All items must be properly braced and supported, and properly distributed in the trailer bed over axles as regulated. Be sure to review all trailer and axle load limits, and any applicable regional and local load restrictions when loading trailers with any Aeterna™ Sintered Slabs for road transportation.

ARTICULATED TRUCKS



	BUNDLE-FRAMES	
RECOMMENDED LOADING PATTERN		
THICKNESS	6 MM	12 MM
# OF BUNDLE-FRAMES	10	
# OF SLABS	400	200
M ²	2048	1024
KG	31070	
SQFT	22560	11280
LB	68500	

The values provided are indicative; please use as a general guide.
 The quantity transported may vary depending on the weight limits of the country/region.



	BUNDLE-FRAMES	
RECOMMENDED LOADING PATTERN		
THICKNESS	6 MM	12 MM
# OF BUNDLE-FRAMES	9	
# OF SLABS	360	180
M ²	1843.2	921.6
KG	27963	
SQFT	20304	10152
LB	61650	

The values provided are indicative; please use as a general guide.
The quantity transported may vary depending on the weight limits of the country/region.

PRODUCT HANDLING AND STORAGE

To prevent the risk of breakage or chipping, slabs should be handled with the greatest care and attention, in full compliance with safety regulations and with their edges protected at all times. For all types of handling and storage, always check the payload of the loading, unloading and handling systems and ensure that the slabs are always perfectly balanced.

SLAB SIZE CM	160 X 320 CM, 6 MM THICKNESS	162 X 322 CM, 12 MM THICKNESS
SLAB SIZE INCHES	63 X 126	64 X 127
WEIGHT OF SINGLE SLAB KG	75	150
WEIGHT OF SINGLE SLAB LB	165.3	330.7

The values provided are indicative; please use as a general guide.

HANDLING WITH MECHANICAL CLAMP

To remove a 6 mm or 12 mm thick slab from a Bundle-Frame, first remove the top frame cross member, and the front support frame using a 19 mm wrench or a 19 mm socket wrench affixed to a power driver/drill. Slabs can be held in place once the frame front is removed using adjustable hand clamps if desired.

TOOLS:

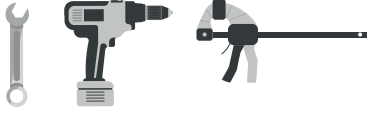

Mechanical clamps are able to handle 1 slab at a time, however, verify any weight restrictions with the actual local equipment being used. ENSURE ALL SEPARATOR WAX, DEBRIS, AND ANY OTHER MATERIALS ARE REMOVED / CLEANED FROM THE AREA OF THE CLAMP PRIOR TO CLAMPING TO AVOID DAMAGES TO THE SLAB.

This method comprises a hydraulic system complete with a gantry crane, carrying a double clamp which grips the slabs in two points to prevent them from bending and breaking. Before lifting, clean the slab contact points to ensure that they do not slip out of the clamp. Rubber fittings should also be placed on these points, so that the steel clamps do not touch the slabs.



If a double clamp is not available, a single one can be used, enlarging its contact point by inserting a strip of wood of 300x20x2 cm. This is necessary for rotation or twisting of the slab, which could cause it to break.



Alternatively, the ideal equipment for handling several slabs at a time is a gantry crane with slings, which must always be made of canvas and never metal, since the latter type might damage the slabs. Stack multiple slabs only if they are all the same size.



MANUAL HANDLING

One slab at a time can be transported by hand with the aid of a frame with a sufficient payload to support the weight of the slab, with adjustable suction cups which hold the slab in place so that it cannot bend. At least 4 people are required to handle a slab 6 mm thick and 6 people for a slab 12 mm thick.

Once the sheets have been removed from the pallet, care must be taken when placing slabs. Ensure slabs are protected when laid on floors and walls.

RECOMMENDATIONS

A) PLAN ALL MOVEMENTS IN ADVANCE BEFORE PROCEEDING TO MOVE THE SLABS.

B) MAKE SURE THAT THE SLABS DO NOT BOW OR BEND IN THE MIDDLE.

C) USE PROTECTIVE GLOVES.

D) HANDLE THE SLABS IN TEAMS OF AT LEAST 4 PEOPLE FOR 6 MM, AND 6 PEOPLE FOR 12 MM.

E) MOVE THE SLABS PERPENDICULAR TO THE FLOOR.

F) DO NOT REST THE SLABS DIRECTLY ON THE FLOOR.

G) REST THE LONGEST SIDES ON STRIPS OF SOFT MATERIAL (LIKE WOOD OR POLYSTYRENE) AND SHORTEST SIDES ON FIRM SUPPORT.

H) BEFORE PILING THE SLABS ON TOP OF ONE ANOTHER, CLEAN THE SURFACE WELL TO PREVENT SCRATCHES.

I) ENSURE THE SLAB TRESTLE IS PROPERLY SUPPORTED AT ALL TIMES. DURING ANY MOVEMENT, ALWAYS ENSURE SLABS ARE PROPERLY SECURED TO THE TRESTLE – NEVER MOVE WHEN SLABS ARE LOOSE. USE PIECES OF CARDBOARD UNDER ANY BUCKLES OR RATCHET TO PREVENT DAMAGE TO THE SLAB. ALWAYS USE “KICKSTANDS” OR RESTRAINTS TO ENSURE SLABS CANNOT FALL OVER AT ANY TIME.

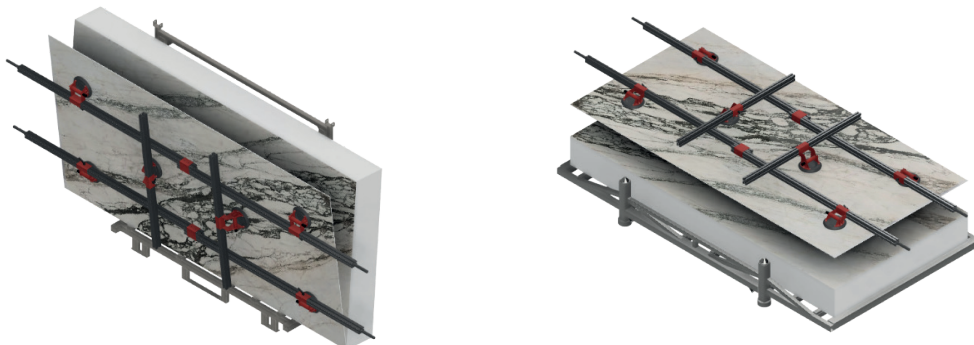



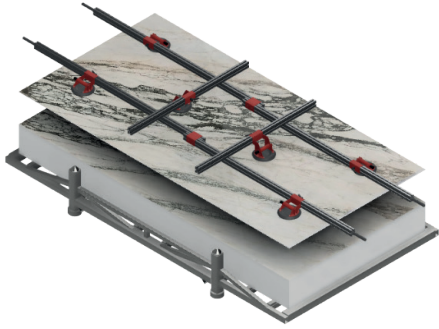

HANDLING SLABS IN A FLAT POSITION

The easiest and most practical way to handle slabs is in a flat position. For example, placing slabs on a stable support will allow for handling and applying the adhesive easily (movable frames). Always make sure that the frame is equipped with controlled vacuum suction cups, which allow for continually measuring their adhesive strength using a pressure gauge. When carrying slabs, it's crucial to avoid oscillation, vibration, and any sudden changes in direction as much as possible.

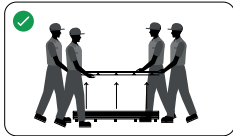

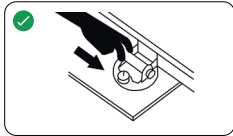
RECOMMENDATIONS

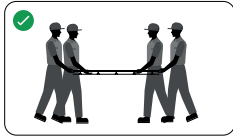
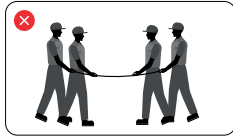
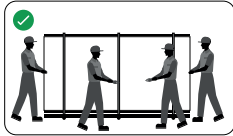
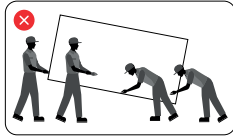
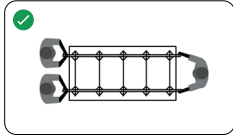
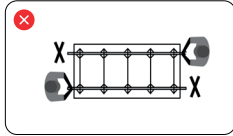
	YES	NO
A) LIFT THE SLABS FROM THE CASE USING SUITABLE VACUUM LIFTING FRAMES.		
B) WHEN MOVING INDIVIDUAL SLABS, USE CONTROLLED VACUUM LIFTING FRAMES WHERE POSSIBLE. CHECK THAT THE NUMBER AND RATING OF THE VACUUM DEVICES IS SUITED TO THE WEIGHT OF THE SLAB BEING MOVED.		
C) USE CONTROLLED VACUUM LIFTING FRAMES.		
D) THE VACUUM LIFTING FRAME CAN BE ATTACHED TO A STABLE SUPPORT SO IT CAN BE MOVED IN AN UPRIGHT POSITION AND ADHESIVE CAN BE APPLIED (MOVABLE FRAMES).		
E) SLABS MEASURING UP TO 160 X 320 CM SHOULD BE HANDLED USING VACUUM LIFTING FRAMES BY 4 PEOPLE (OR NO FEWER THAN 3), POSITIONED AT EACH CORNER OF THE SLAB.		

HANDLING SLABS IN AN UPRIGHT POSITION

For the 162 x 322 cm format slab, we recommend using the following:

- mobile vacuum lifting frames with pneumatic rotation
- lifting clamps
- lifting slings with soft straps (avoid steel cables or chains) which can also be used for moving more than one slab at a time.

For any lifting system, the weight to be lifted must be properly balanced around the lifting point. All operations must be carried out by trained personnel, using equipment rated for the weight being handled. When using clamps or vacuum lifters, be certain to clean dust or any other material from the surfaces beforehand to ensure a good grip. If single slabs need to be moved by hand (not recommended), suitably rated vacuum lifting frames are recommended, carried by at least 4 operators.

Take maximum care when moving single 162 x 322 slabs packed on a Bundle-Frame, especially after removing the protective strapping. The slabs should be moved only by trained and authorized personnel, wearing suitable personal protection and using appropriate lifting devices. Be certain to balance the weight equally as the slabs are being removed. Inspect the Bundle-Frame before unpacking the slabs to ensure integrity and stability. The safety of the workers handling the slabs always comes first. Slabs can be held in place once the frame front is removed using adjustable hand clamps if desired.

TOOLS:

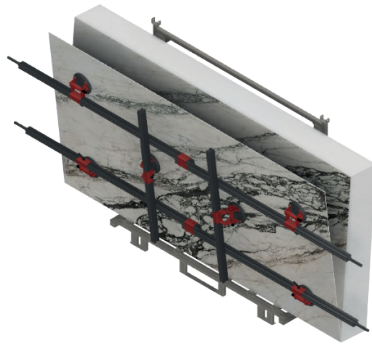
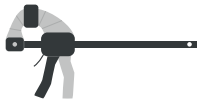

HANDLING FABRICATED PIECES

During transport and movement, it is crucial to avoid any and all shock or impact, especially on the edges or around the top area of the slabs. For best practices, move the slab in an upright position without using the holes or cutouts as support points in order to avoid cracks or breakages in these more delicate points. If the fabrication includes the addition of a pre-assembled sink, be sure to provide a wooden box with the proper support to be able to sustain the weight of the pre-assembled sink, to not generate any torsion across the slab.

RECOMMENDATIONS

A) AFFIX THIN, LONG PARTS (SKIRTING, FOR EXAMPLE) WITH CLAMPS TO AN ALUMINUM ROD FOR TRANSPORT. THIS WILL PREVENT THE SLAB FROM FLEXING DURING HANDLING.

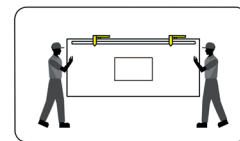

B) COVER THE SLAB DURING THE TRANSPORT WITH WOODEN BOXES OR SPECIAL TARPULINS, PAYING EXTRA ATTENTION TO PROPERLY PROTECT ALL EDGES AND CORNERS.



STORAGE

Aeterna™ Sintered Slabs can be stored on A-frame or traditional racks for stone and quartz-like material. For the safety of both slabs and operators, it is recommended that the slabs are held with belts and protective straps. It is also recommended to apply support systems with anti-slip grooves when placing slabs on racks in order to avoid breakages and chipping.

When using slab racks designed with support columns towards the inside of the slab, the ends of the slab unsupported by the columns may, over time, lead to the development of a natural curvature/temporary set/deformation that generally disappears when the slab is re-positioned on the workbench. However, if Aeterna™ Sintered Slabs are to remain in racking for longer/extended periods of time, this style of racking would not be recommended as the set could possibly become permanent, or harder to remove. Instead, use racks designed for slabs which provide complete support of the slab piece over its entire length. An alternative method, should the fabrication area contain multiple types of materials, is to use a granite or marble slab (do not use wooden ones) with facial dimensions larger than that of the Aeterna™ Sintered Slab, on which to place the Aeterna™ Sintered Slabs against to provide additional support for a prolonged time and maintain the integrity of the flatness of the slab.



When slabs are set in an upright position be sure to place smaller slab pieces in front of the entire slabs in order to avoid imbalances in the support system. Always place slabs with larger dimensions at the back and smaller slabs at the front.

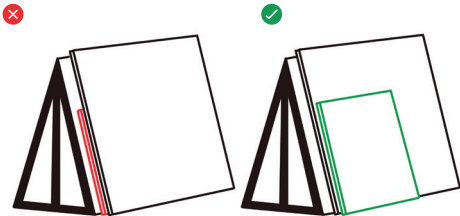

THE WORLD OF ANATOLIA

We are a constellation of people and places. Get in touch.

CANADA
TORONTO HEAD OFFICE,
SHOWROOM AND DISTRIBUTION
CENTER
8300 Huntington Road
Vaughan, ON, L4H 4Z6
Canada

Toronto Sintered Slab
700 Anatolian Drive
Vaughan, ON, L4H 5H7
Canada

info@aeternasurfaces.com

Tel: +1 905 771 3800
Toll free tel: 1 877 311 3434
Fax: +1 905 771 6300
Fax: +1 866 324 1838

USA
Savannah Office, Showroom
and Distribution Centers
Anatolia (USA) Inc.
Tel: +1 877 311 3434

SAVANNAH WAREHOUSE #1
202 International Trade Pkwy
Port Wentworth, GA, 31407
USA
Tel: +1 912 438 5167

SAVANNAH WAREHOUSE #2
250 International Trade Pkwy
Port Wentworth, GA, 31407
USA
Tel: +1 912 438 5167

TURKIYE
IZMIR OFFICE, SHOWROOM, DISTRIBUTION CENTER AND MANUFACTURING FACILITY
Aliğa Organize Sanayi Bölgesi
Çoraklar Mah. 5000 Sk. No: 25
35800 Aliğa, İzmir,
Türkiye
Tel: +90 232 520 7300

REGIONAL Offices
CHINA
Room 517 Yi Shu Da Lou Ji Hua 4 Road
Chan Cheng District, Foshan City
Guang Dong Province, 528000
China

INDIA
206 - Pacific Business Park
Mahendra Nagar (Part)
8/A - National High Way
Morbi, Gujarat, 363642
India

USA
Anatolia (USA) Inc.
131 Crosslake Park Dr., Suite 202
 Mooresville, NC, 28117
USA
Tel: +1 877 311 3434

Partnerships and Associations

idc

interior designers of canada
designers d'intérieur du canada

TTMAC  ACTTM

AMERICAN
SOCIETY OF
INTERIOR
DESIGNERS



RESOURCES

Discover our thoughtfully curated library of resources, designed to bring your vision to life with precision and ease.

SAFETY DATA SHEET – NORTH AMERICA
SAFETY DATA SHEET – EUROPE
SAFETY DATA SHEET – EUROPE (ARABIC)
CARE + MAINTENANCE
TECHNICAL MANUAL: INSTALLATION
TECHNICAL MANUAL: FABRICATION
TECHNICAL INFORMATION
WARRANTY

For additional information, please refer to the available resources.



DISCOVER MORE AT
AETERNASURFACES.COM